

GO COSMOS STYLE DOWNHOLE LOW VOLTAGE ZENER POWER SUPPLY

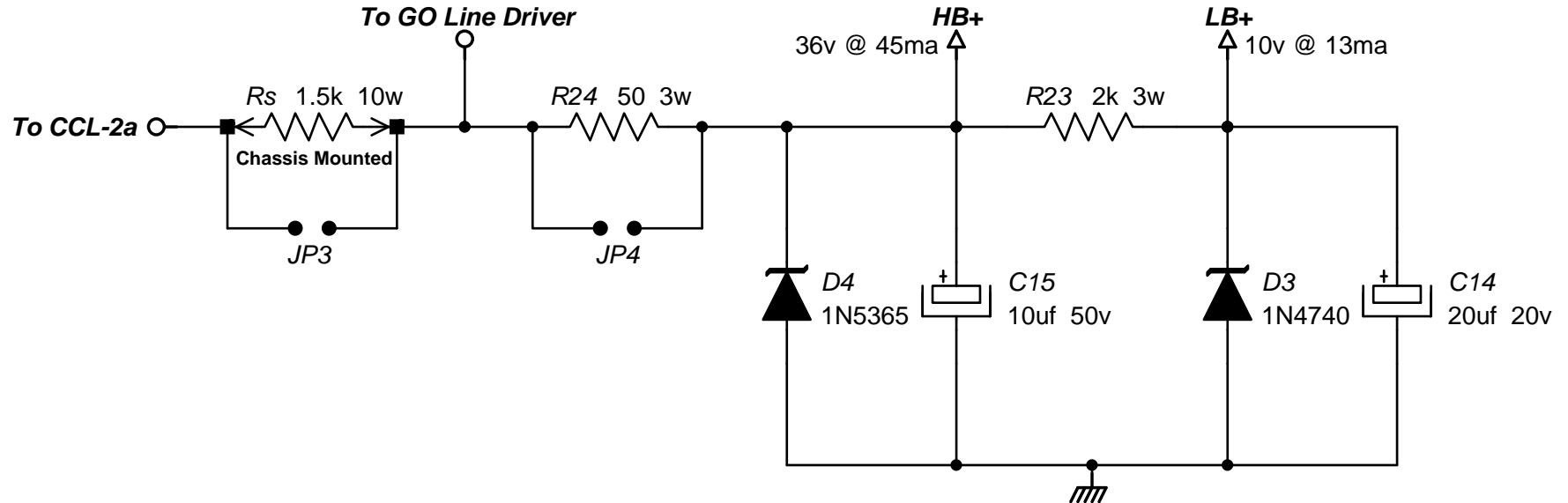

Copyright 1999 by AnaLog Services, Inc. All rights reserved.
 Reproduction is unlawful without express written permission.

NOTES:

Rs is used for 120 volt operation; when used, capacitor bypassing is required.
 If Rs is used and R24 omitted, zener diode pulse height clamping is required.
 See PCB Application Notes for CCL-2a / PS-2a for details.

AnaLog Services, Inc.

1169 Haynesville Road - Reynolds Station, KY 42368 (270) 276-5671 Fax: (270) 276-5588

COSMOS Replacement
 Low Voltage Power Supply

GOPS-2a.sch

Sheet Size: A

Creation Date: 02/27/1999

Drawn By: Syd H. Levine

Revision: 1.0

Modify Date: 11/12/2009

Sheet 1 of 1